

RS485 PTZ Controller with Mini Joystick

PTZJOYMINI



INSTRUCTION MANUAL

Keyboard Controller Parameters

Item	Description
Power Supply	DC12v 1A
Temperature	-10°C - +55°C
Humidity	<90% RH
Communication	RS485 Half duplex
Baud Rate	2400, 4800, 9600, 19200, 38400bps
Screen	128 x 32 LCD screen
Dimensions	180 x 165 x 90mm

List of Additional Items

Name	Quantity	Description
Power Supply	1	Input: 240vAC 50/60Hz Output: 12vDC

1. Keyboard Controls

1.1 Function Keys

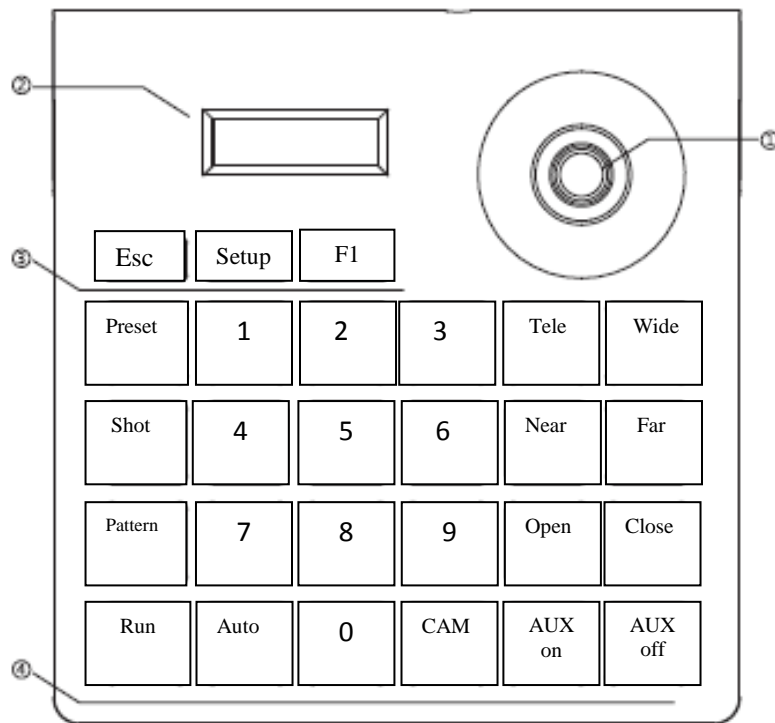

1. Joystick

2. LCD Screen

3. Function Keys

4. PTZ camera setup and recall keys.

Esc Exit key: Exit and back to previous menu

Setup Setup key: press and hold for 3 seconds to setup parameters

F1 Adjust control speed. Four speeds 1, 2, 3 or 4

Preset Sets preset points including direction and zoom times.
Use together with number key

Shot Calls preset points including direction and zoom times.
Use together with number key.





Pattern	Starts/stops pattern record. Press for three seconds to start pattern record. After completion press this key again to stop recording. Use together with number key.
Run	Runs the stored pattern. Use together with number key.
0 ~ 9	Number keys 0, 1, 2, 3, 4, 5, 6, 7, 8, 9
Auto	Controls PTZ rotation in a horizontal direction automatically or clears input number. When user inputs numbers they can press this key to delete the numbers else the PTZ will rotate in a horizontal direction.
CAM	Address selection key. Selects PTZ address. Use with number key.
Tele	Zoom in to enlarge the object size.
Wide	Zoom out to reduce object size.
Open	Iris + and enlarge iris.
Close	Iris – and reduce iris.
Far	Focus + adjust lens on long distance.
Near	Focus – adjust lens on near object.
Aux on	Turn on PTZ Aux function. This key should be used with number key. Press key without a number and the controlled PTZ ID will add 1.
Aux off	Turn off PTZ Aux function. This key should be used with number key. Press key without a number and the controlled PTZ ID will deduct 1.
Press Joystick	Press and hold for 3 seconds to call preset 95 to open PTZ menu. Of course this only applies to cameras with a PTZ menu using the CALL 95 command for menu display.

1.2 LCD Screen





Press each function key for LCD screen to display relevant information. Holding the key will display relevant information and will disappear when key released. When there is no operation over 30 seconds it will drop into power saving mode.

1.3 Joystick

CAMERA NORMAL MODE

Operating	Output Control	Operating	Output Control	Operating	Output Control	Operating	Output Control
	Upward		Downward		Left		Right

CAMERA SETUP MODE

Operating	Output Control	Operating	Output Control	Operating	Output Control	Operating	Output Control
	Menu turned up		Menu turned down		Parameter of the left		Parameter of the right

2. KEYBOARD CONTROLLER OPERATIONS

2.1 Introduction to single-press keys & combined keys

2.1.1 Single Press key: When a single key is pressed the corresponding PTZ will respond. Single press keys Include: Near, Far, Tele, Wide, Open, Close, Auto, F1, Run, Esc and Joystick.

2.1.2 Combined key operations means or more keys, or key and the joystick are pressed, then the corresponding PTZ operation will respond.

The operations Include: [Preset] , [Pattern] ,[Shot] , [Cam] , [Setup] .

2.2 Detailed introduction to combined keys

2.2.1 Select PTZ ID 28 for example::

Select speed dome or decoder whose ID is 28: press 2, 8, CAM in turn, then LCD will display as below (corresponding protocol and baud rate will also be shown).



PTZ ADDR: 028 ④
P:PELCOB B:2400

2.2.2 Set and Call pattern:

Set pattern: Select PTZ Addr., Press pattern key and hold for more than 3seconds, then LCD will display:



PTZ ADDR: 028 ④
PATTERN RECORD

Operate joystick to control PTZ moving to relevant position and adjust zoom time.

After setup press pattern key to finish. LCD will display:



PTZ ADDR: 028 ④
PATTERN STOP

Call pattern : press Run key. PTZ will run the recorded pattern;
Pressing any single-press key will stop pattern record.

Note: This keyboard supports setting only one pattern at present.

2.2.3 Set and call preset point:

Set preset point 1:
key in **1**, press [Preset) .

Call preset point 1:
key in **1**, press [Shot) .

2.2.4 Turn on/Turn off aux function

Turn on : Open aux. function, press **1**, press AUX on.

Turn off: Close aux. function, press **1**, press AUX off.

3. Parameter Setup

3.1 PTZ Parameter Setup

Example: Change protocol for PTZ 28 to PELCO-P and baud rate to 9600.

```
PTZ ADDR: 028 ④  
PASSWORD: ----
```

Key in password (default: 8888), press joystick, then LCD will display:

```
*PTZ SETUP  
SYSTEM SETUP
```

Press joystick, LCD will display:

```
*PTZ ADDR: 001  
P:PELCO0
```

Move the joystick towards the left/right to select PTZ 28, then LCD will display:

```
*PTZ ADDR: 028  
P:PELCO0
```

Press joystick and LCD will display:

```
PTZ ADDR: 028  
*P:PELCO0
```

Move the joystick right and LCD will display:

```
PTZ ADDR: 028  
*P: PELCOP
```

Press joystick, finish protocol setup and switch to baud rate setup, the LCD will display:

```
PTZ ADDR: 028  
*B: 2400
```

Move the joystick to the right until LCD displays:

```
PTZ ADDR: 028  
*B: 9600
```

Press joystick, finish setup and back to select PTZ ID menu, then repeat above steps for other PTZ cameras or set other PTZ parameters.

- After finishing setup, press Esc key to quit setup. Note: If you want to set all PTZ protocols and baud rates the same, when you select PTZ ID in setup menu, please select 0-255.

```
*PTZ ADDR: 0-255  
P:PELCO0
```

3.2 System Parameter Setup

System parameters include : Language, password, key-press volume, key backlight, and default factory setup.

The following example is the default factory setup operation steps:

In normal status, press and hold **Setup** key for more than 3 seconds to display:

```
PTZ ADDR: 028 ④  
PASSWORD: ----
```

Key in password (default password:8888) press joystick and LCD will display:

```
*PTZ SETUP  
SYSTEM SETUP
```

Move the joystick down the LCD will display:

```
PTZ SETUP  
*SYSTEM SETUP
```

Press joystick and LCD will display:

```
*LANGUAGE  
PASSWORD SETUP
```

Move joystick until LCD displays:

```
*DEFAULT FACTORY  
SETUP
```

Move joystick right and LCD will display:

```
*DEFAULT FACTORY  
SETUP ?
```

Press joystick and the buzzer will emit a long buzz and when the question mark (?) disappears this will denote setup has finished. Press **Esc** to quit setup.

3.3 Parameter Setup Diagram

PTZ SETUP	PTZ addr : xxx	Protocol	PELCO-D, PELCO-P
	PTZ addr : 0.254 (All PTZ parameters will be set the same)	Baud Rate	2400, 4800, 9600, 19200, 38400
SYSTEM SETUP	Language	Chinese, English	Move joystick to select
	Password Setup	Old Password :	4 digit number
		New Password :	4 digit number
		Enter Again :	4 digit number
	Key press sound volume	close, low, mid, high	Move joystick to select
	Key backlight (optional)	close, 30s, 60s, 120s, open	Move joystick to select
	Default to factory settings	N/A	Move and press joystick to select

4. Typical Connections Diagram

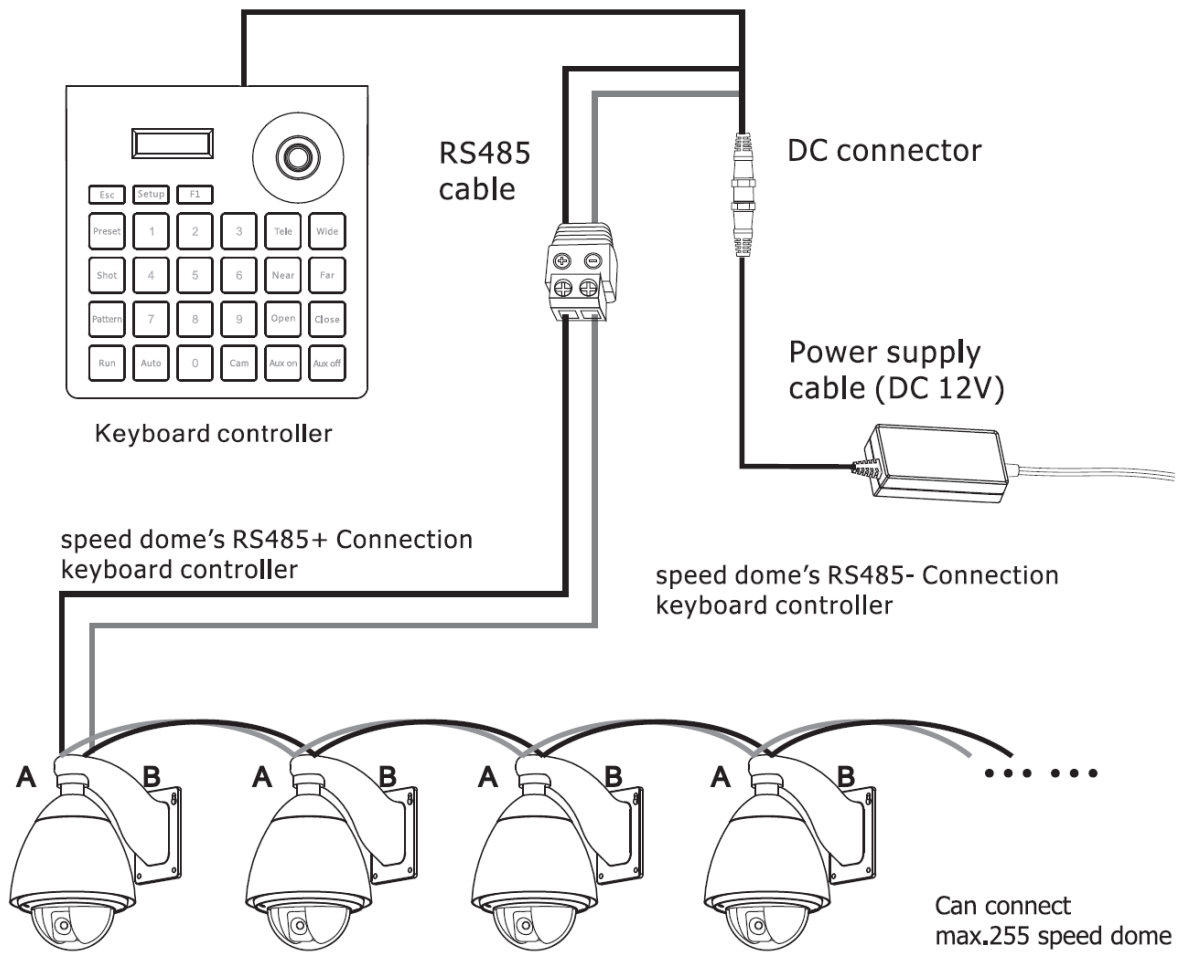

5. Frequently Asked Questions

Symptom	Action	Information
Keyboard does not control the PTZ camera	1. Check RS485 hardware	a. Check RS485 + and – are correct at both ends. b. Check RS485 continuity
	2. Check RS485 software settings address, protocol and baud rate	a. Check address, protocol and baud rate agree with that set in PTZ camera. b. After changing settings to agree with PTZ settings ensure all equipment is rebooted to apply them.
Some PTZ cameras can be controlled but some are not	1. Check hardware	a. Check cable continuity
	2. Check software settings	a. Check address, protocol and address for each camera
	3. May be a problem with RS485 termination	a. Try switching on 120 ohm termination resistor. b. Fitting an RS485 distributor between PTZ cameras and keyboard may be required.
More than one PTZ responds simultaneously when operating keyboard	1. Check the PTZ addresses set in the PTZs.	a. Change the PTZ addresses of the PTZs that are being simultaneously moved
No key sounds	Turn on key tone in System Settings	

All specifications are approximate. Kovert.com reserves the right to change any product specification or features without notice. Whilst every effort is made to ensure that these instructions are complete and accurate, kovert.com cannot be held responsible in any way for any losses, no matter how they arise, from errors or omissions in these instructions, or the performance or non-performance of the camera or other equipment that these instructions refer to.



WEE/CG0783SS

This symbol on the products and/or accompanying documents means that used electronic equipment must not be mixed with general household waste. For treatment, recovery and recycling please return this unit to your trade supplier or local designated collection point as defined by your local council.